	<h1>340</h1>	
	<b>VEHICLE DETECTION</b>	
	Enforcement Radar Traffic Detector	

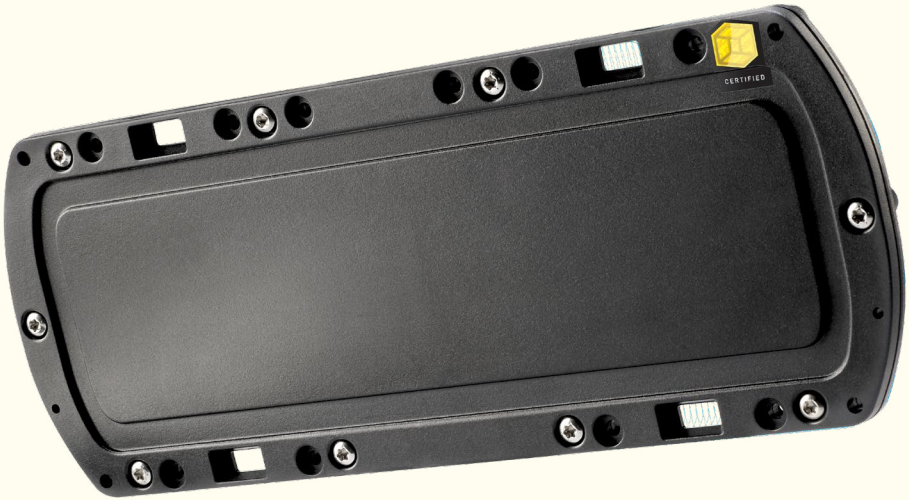

# PRODUCT MANUAL



# TABLE OF CONTENTS

<b>INTRODUCTION</b>	
Product & technology	3
Key features	3
Typical applications	4
Product overview	4
<b>INSTALLATION</b>	
Radar installation & alignment	5-6
<b>SYSTEM HARDWARE OVERVIEW</b>	
System hardware overview	7
RS422 serial interface	8
Temperature sensor	8
Non volatile memory	8
Power supply	9
Input protection	9
Radar connectors	9
IQ internal connectors	10
Hardware simulated target	10-11
Overview	12
Tasks	12
Detection task	13-14
Target tracking	15-16
Radar characteristics	17
Radar performance	18-19
<b>RADAR COMMANDS</b>	
Radar Command list	20-22
25KHz reference signal & the *FE command	23
Radar initialisation	23
<b>MESSAGE FORMATS</b>	
Radar event messages	24-28
Radar status messages	29-35
Radar Error messages	36
<b>ANTENNA PLOTS</b>	37
<b>TECHNICAL SPECIFICATIONS</b>	
Product specification	38
<b>TEST &amp; CALIBRATION</b>	
Dedicated test equipment	39
<b>MANUFACTURING TEST PROCESS</b>	
Hyperion Test Equipment	40
<b>IMPORTANT SAFETY INFORMATION</b>	
Safety precautions	41
Low power non-ionising radio transmission and safety	42
<b>CERTIFICATION</b>	43-45
<b>DISCLAIMER</b>	48
Warranty	48

# INTRODUCTION

## PRODUCT & TECHNOLOGY

---



# 340

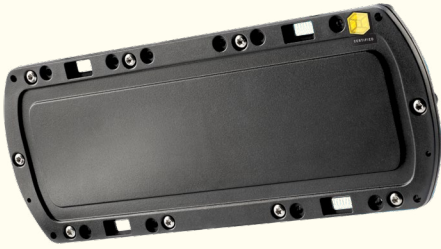

This product has been designed specifically to measure the speed of passing vehicles for enforcement purposes. The 340 CW Doppler radar operates in the K-band at 24GHz. It is suitable for many national requirements.

- Vehicle speed enforcement radar detection
- Technically advanced detection platform
- Fixed and mobile deployment options
- Proven reliability

## KEY FEATURES

---

- Market leading speed measurement Doppler vehicle radar
- Speed measurement from 20kph to 300kph across multiple lanes
- Custom designed planar antenna
- Ease of integration into host system
- High speed RS422 serial communications to host equipment
- Can discriminate between approaching and receding traffic

# INTRODUCTION

## TYPICAL APPLICATIONS

Speed enforcement radar traffic detection - approaching

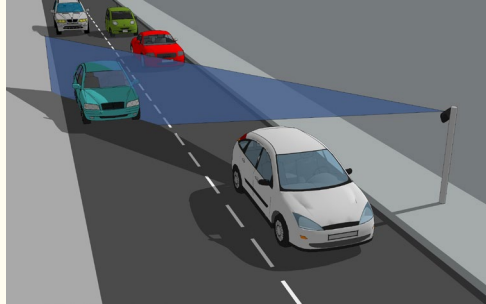

Speed enforcement radar traffic detection - receding

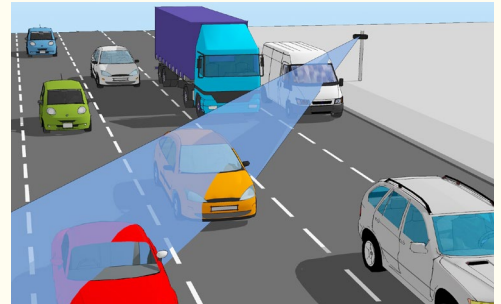

## PRODUCT OVERVIEW

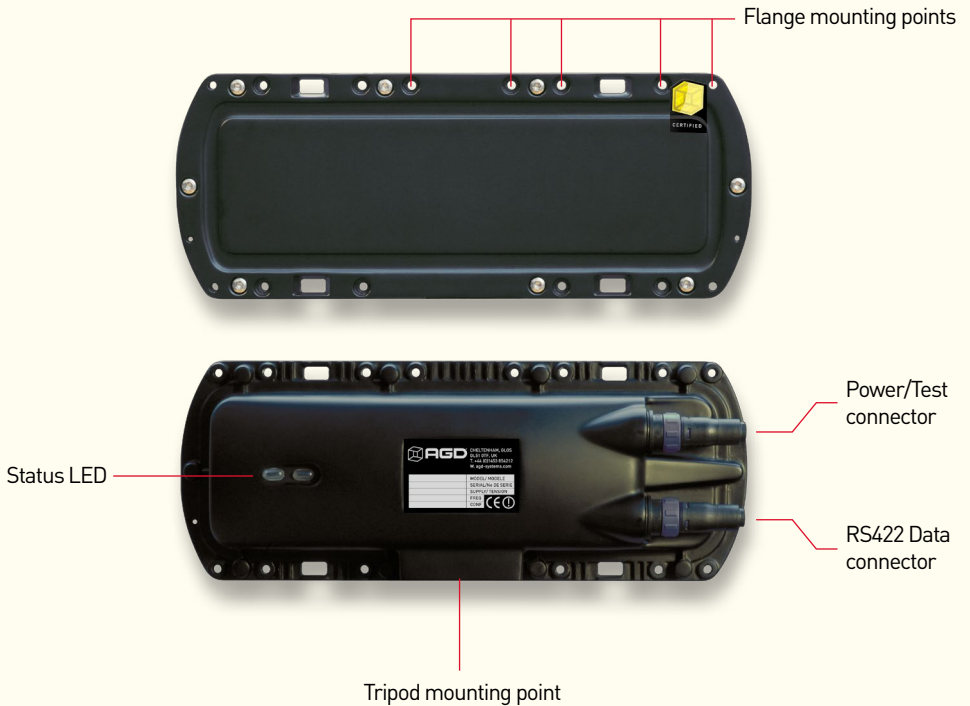

## RADAR INSTALLATION & ALIGNMENT

For best detection performance the radar must be setup correctly. Failure to do so can result in inaccurate or false detections.

### Radar Mounting Angle

Radars are supplied factory programmed to be used for a specific mounting angle, usually to 22 degrees. This angle is the angle the radar points across the road from the direction of the road, see diagram below. The angle a radar is setup for is printed on the top side of the radar. The angle is also reported in valid detect messages and the command \*AD may be used to determine it. This angle is used by the radar to adjust the speed the radar measures to the actual target speed and therefore it is important the radar is setup with the correct angle. If the radar is setup with an angle that is less than the mounting angle then the radar will measure speeds that are larger than the vehicles true speed, while if the angle is greater than the mounting angle the radar will measure speeds that are less than the vehicles true speed.

The radar transmits a radio beam across the road that has a horizontal beam width of ~5 degrees. The vertical beam width of the radar beam is relatively large at 15degrees so although the radar should be made level this is not crucial for correct operation. For a fixed camera installation often the radar is mounted relatively high (~3m) and in this case it is desirable to point the radar more down towards the ground. In this application careful consideration of the radar beam and its shape is required to ensure that all the lanes of the road are covered.

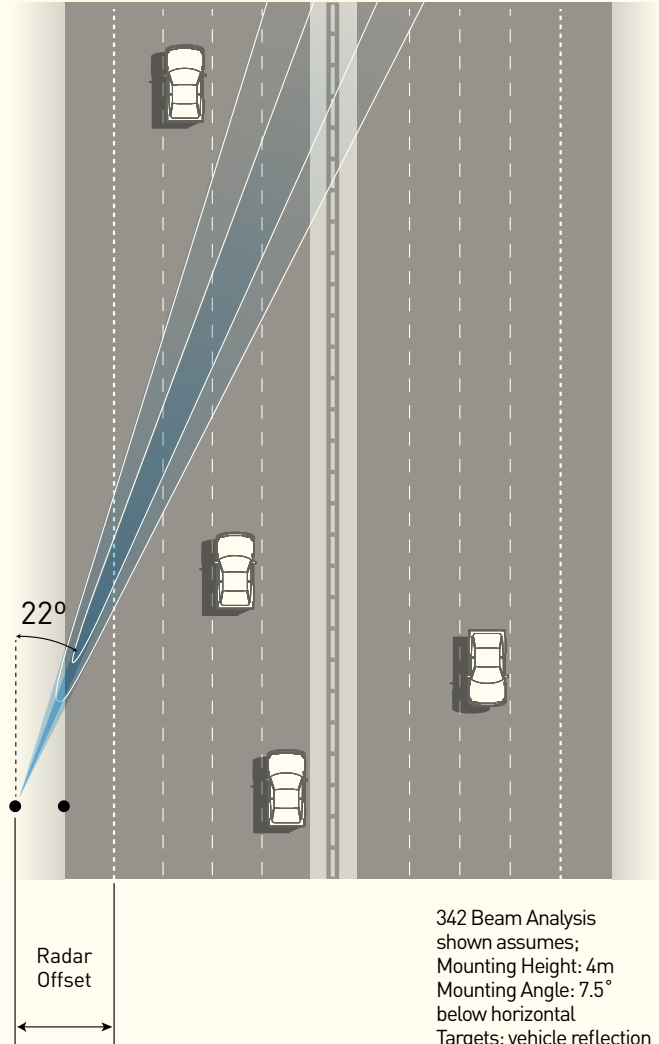

342 Beam Analysis shown assumes;  
Mounting Height: 4m  
Mounting Angle: 7.5°  
below horizontal  
Targets: vehicle reflection  
from a height of 1m

# INSTALLATION

## RADAR INSTALLATION & ALIGNMENT

### Sensitivity Level

The radar has two sensitivity levels to allow it to operate in most situations. The sensitivity level is adjusted using the \*SL command. If the radar is being used to monitor only two lanes of a road then the low sensitivity level should be chosen. This is particularly important in an urban environment where the radar may pick up reflections and falsely trigger the camera that will take a picture of a non-existent or incorrect vehicle. This is illustrated opposite where the radar has triggered the camera because it has detected a speeding car from its reflected signal off a building. By setting the sensitivity level of the radar to low, this weak reflected signal is often not detected.

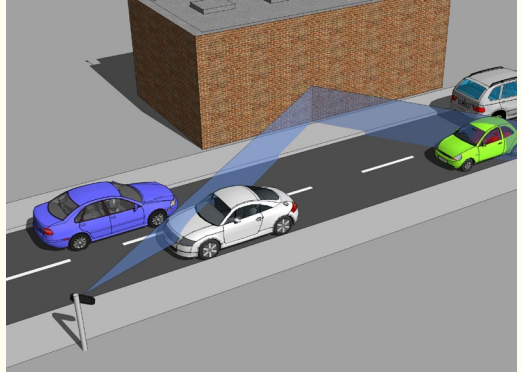

### High sensitivity false detections in an urban environment

To reduce further the possibility of detecting reflections the radar should not be pointed at any large vertical flat surfaces which may reflect the radars transmissions. This is particularly true if the surface is metal.

When the radar is monitoring 3 or more lanes the high sensitivity mode of the radar maybe used. The radar, even in low sensitivity mode, will detect most vehicles on a four lane road but some targets with small radar signal returns may not be detected in the far lanes e.g. motorcycles.

### Dual Direction Mode

The radar can be set in a mode to detect speeding vehicles travelling in both directions. This is possible because the radar has a very good direction sensing capability that allows it to detect vehicles travelling in both directions at the same time as long as they have different speeds. Each direction is tracked totally independently. In this mode the vehicle travelling on the opposite side of the road may not be detected correctly because the signal is blocked by a vehicle nearer to the radar. It is therefore recommended that the radar is setup to detect vehicles on the far side of the road using beam entry messages and nearby targets using the beam exit messages. The diagram below shows what can happen in an incorrect setup. In an incorrect setup the vehicle in the far lane is detected correctly and a beam entry message is sent. This message would not be used to take a photo though as the rear number plate cannot be seen yet. However, moments later a car travelling in a lane nearer to the radar blocks the signal from the far vehicle and so the radar sends a beam exit message and the system would then take a photo. However the far vehicle is not in view and therefore no conviction can be made. In the correct setup though as soon as the radar detects the speeding far vehicle a beam entry message is sent and a photo is taken, although the vehicle will still have to be in the beam for a significant amount of time so that it is not rejected for being too short a vehicle. Moments later the near vehicle blocks the signal from the far target and

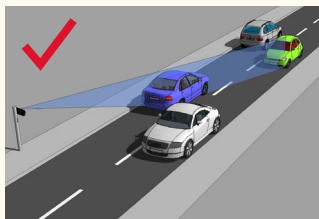
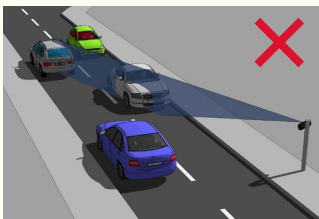

a premature beam exit message is sent but a photo has already been taken and a safe conviction may be made. Note in this mode it is possible for the target messages to be interleaved between each other when targets are travelling in the beam at the same time but in different directions.

# SYSTEM HARDWARE OVERVIEW

## SYSTEM HARDWARE OVERVIEW

---

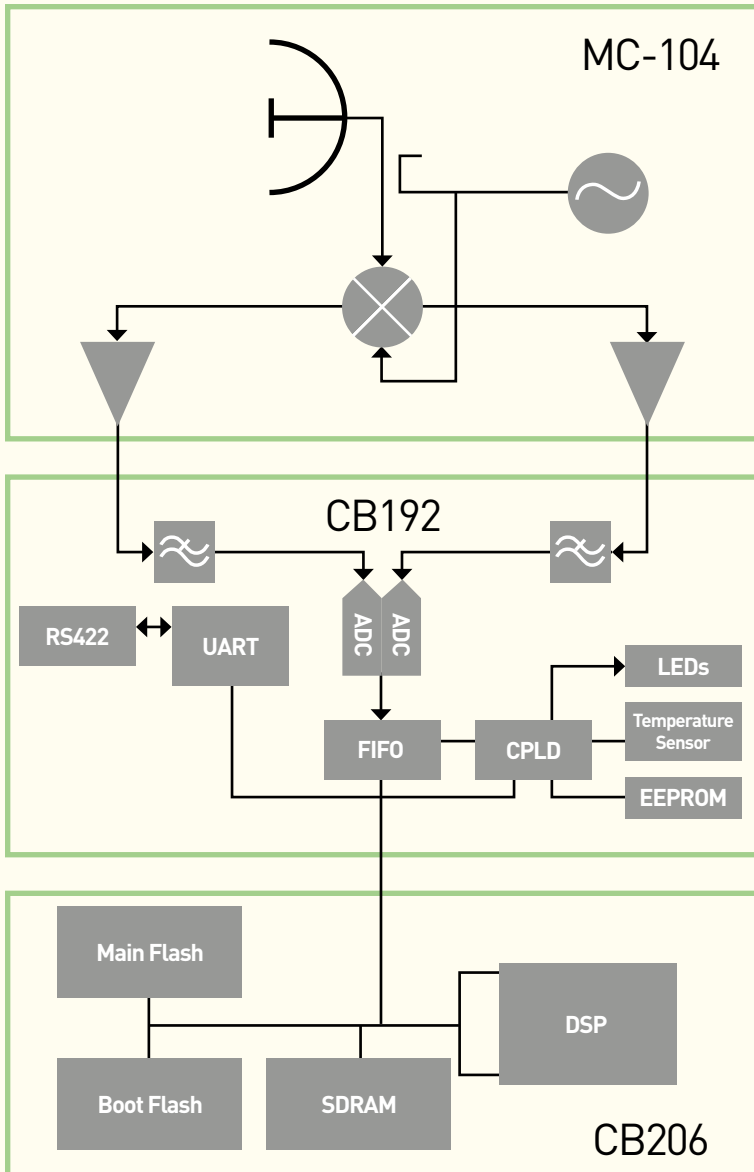

# SYSTEM HARDWARE OVERVIEW

## RS422 SERIAL INTERFACE

---

A UART interface is provided using RS422 voltage levels. The default baud rate for this interface is 115200. This however maybe changed using the BAUD command to speeds of up to 926000. The BAUD command will store the baud rate into non-volatile memory of the radar ready for the next time the radar boots. When the radar first boots it will always use a baud rate of 115200 to report the radar firmware version and the baud rate that will be used. It then switches to the new baud rate and again reports the radar firmware version.

The serial interface default setup during normal operation is shown in table below.

DEFAULT UART SETTINGS	
Parameter	Value
Baud rate	115200
Data bits	8
Parity bits	None
Stop bits	1
Flow control	None

The RS422 provides the primary output of the radar in the form of ASCII messages. These messages provide speed, beam entry and beam exit information.

The externally visible LED is used to indicate the radar status, see table below.

LED STATUS		
LED on time (seconds)	LED off time (seconds)	Radar condition
3	0.5	Normal operation
0.5	0.5	Error condition

## TEMPERATURE SENSOR

---

A digital temperature sensor has been installed on the digitiser board. This will be used to allow the processor to monitor environmental conditions. The temperature of the radar may be requested using the TEMP command.

## NON VOLATILE MEMORY

---

An EEPROM is installed on the board to provide non volatile memory. The primary use of this EEPROM is to store configuration and calibration data.



# SYSTEM HARDWARE OVERVIEW

## POWER SUPPLY

---

The radar is powered using a DC voltage in the range of 9 to 30 volts. The radar is polarity protected using a diode. The radar can draw a very large current doing power up that is of the order of amps. However, this current only lasts for ~1ms and should not affect most applications.

### POWER CONNECTOR

Pin No	Signal	Description
L	+ve Supply	9 to 30V DC
N	-ve Supply	0V or Ground
E	Earth	

The power connector is a Bulgin PX0412/03P. (Mating Type PX0410/03S/5560 is recommended)

## INPUT PROTECTION

---

A thermal fuse with a 630mA rating has been installed to protect against electrical short circuit fault conditions.

## RADAR CONNECTORS

---

### DATA CONNECTOR

Pin No	Signal	Description
1	A (RX +)	RS422
2	B (RX -)	
3	Z (TX-)	
4	Y (TX+)	
5	<b>Do Not Connect</b>	<b>This is used for a test signal – do not connect</b>
6	Reference Oscillator	24992.54Hz ±50PPM
7	0V	Ground
8	spare	<b>This pin is not fitted to the bulkhead connector</b>

The data connector is a Bulgin PX0412/08P. (Mating Type PX0410/08S/6065 is recommended)

## IQ INTERNAL CONNECTORS

---

The internal connectors J1 and J2 can be used to monitor the in phase and quadrature signals from the microwave front end. The radar has to be opened to access these connectors and should therefore only be performed at calibration time. If using an oscilloscope to observe these signals it should be configured as a high impedance probe. Using a 500hm probe to monitor these signals will distort the measurements.

The internal connectors J1 and J2 can be used to inject I and Q signals into the radar. A low impedance source should be used to provide the signals with a magnitude of up to 5V peak to peak.

## HARDWARE SIMULATED TARGET

---

The radar has a built in hardware based target simulator. This is used during boot up to simulate an approaching and then a receding target. If an error is detected in the simulated target's speed then the radar will send an error message and turn off the ADC clock rendering the radar inactive. The radar can be made to perform a simulated target test at any time by sending a SELF-TEST command. Again if an error is detected in the targets speed the radar will stop. To distinguish real targets from simulated targets the radar inserts an X or a Y in the direction fields of all related messages produced. During simulation the microwave front end is turned off to avoid any possible interference with the simulation.

The CPLD on the digitiser board generates the signals used for the simulated target. These signals are generated using the logic shown in the diagram. The input signals to the logic are:

- **DIR**  
This input selects the direction the simulated circuit will simulate. This signal is controlled by the C6711 processor.
- **CS**  
This input selects whether the outputs are active. This signal is controlled by the C6711 processor.
- **CLK**  
This signal is taken from the ADC sample clock and is the circuits input clock.

The purpose of this logic is to generate two square waves, I and Q, with a frequency that is one sixteenth of the ADC sample frequency (ie  $49985.08475 / 16 = 3124.07\text{Hz}$ ) and out of phase by 90°. This effectively provides a simulation of the expected signals from the microwave module when it can see a Doppler target. The DIR signal controls whether the Q channel lags or leads by 90° and therefore controls the effective direction the simulated target is travelling.

# SYSTEM HARDWARE OVERVIEW

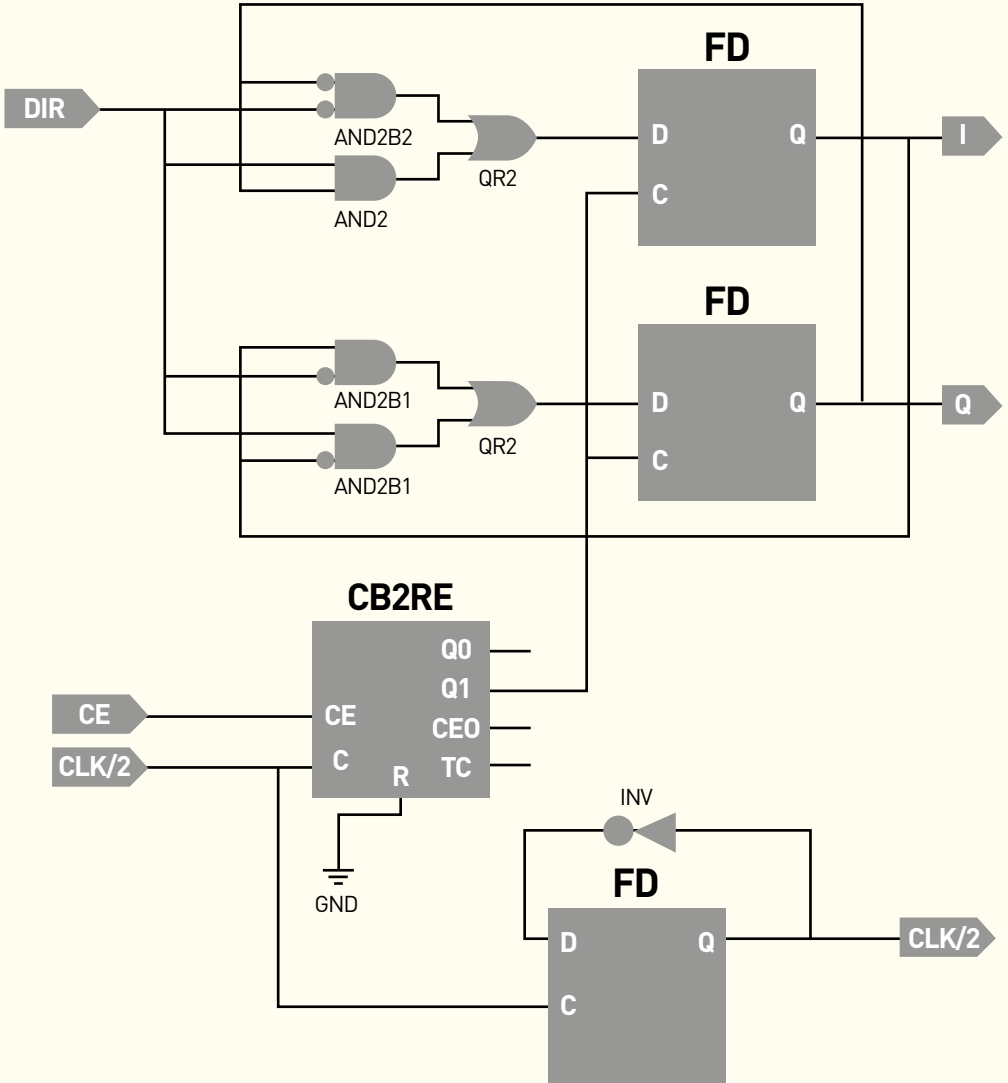

The I and Q signals from the CPLD are then filtered before being applied to the -ve input of the digitisers board input operation amplifiers. The filter reduces the harmonic content of the I and Q signals to a level which the radar can cope with.

# SYSTEM HARDWARE OVERVIEW

## OVERVIEW

---

The AGD340 radar is a real time radar that continuously samples the input. The radar uses a real time operating system that is continuously performing a number of tasks simultaneously using a time multiplexing method.

## TASKS

---

The radar has a number of key tasks that are performed in parallel.

- **Watch Dog Task**

This task has the lowest priority so that if any other task locks up for any reason this task will not be run. If this task is not run then the radar will reset itself automatically after ~0.5 seconds. This task is also used to provide the heartbeat functionality where a message is sent over the RS422 approximately every 10 seconds

- **Detection Task**

This task performs the detection of targets. This task waits for the ADC to complete a block of data collection and then performs the necessary signal processing.

- **RS422 Handling Task**

This task processes data received on the RS422 connection. It processes commands sent to the radar and provides appropriate responses.

- **Configuration Update Task**

The configuration task updates the radar configuration data once every minute. The main purpose of this task is to update the lifetime figures for the radar.

# SYSTEM HARDWARE OVERVIEW

## DETECTION TASK

This task performs the main functionality of the radar to detect speeding vehicles using digitised data from the microwave module. Shown below is the flow diagram for the detection task.

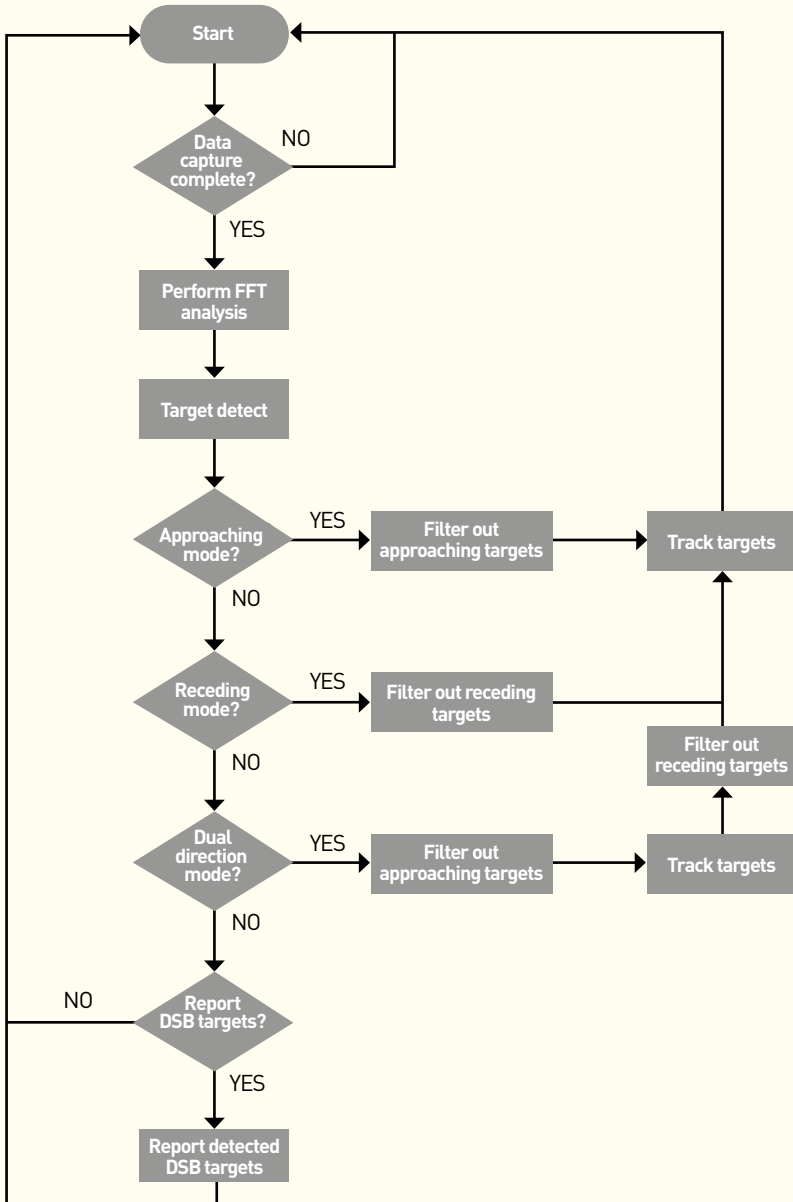

# SYSTEM HARDWARE OVERVIEW

The radar captures data continuously using an analogue to digital converter, ADC, working at ~50KSPS. ADC samples are captured in complex sample packets that are used by the Fast Fourier Transform, FFT, function to perform a 1024 point complex FFT.

The FFT analysis function provides the frequency analysis results that are used by the target detect function to pick out potential targets. The FFT analysis is performed approximately 195 times a second. This enables the radar to have a very fast response time so that it effectively detects fast moving targets.

The Target Detect function takes the FFT analysis data and scans it for potential targets. Shown below is the function's operation.

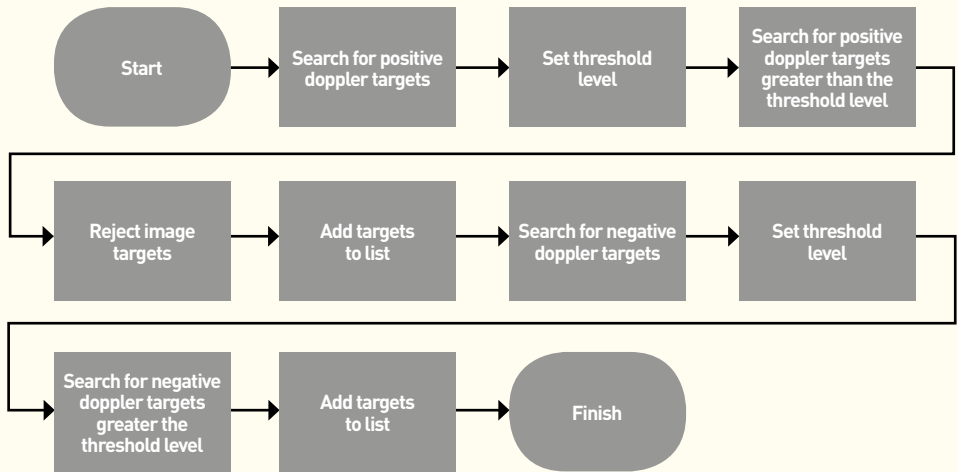

By using an FFT to analyse the data, the radar is able to easily distinguish between advancing and receding targets even when they are present in the beam at the same time. This is why the radar can be used in a dual direction mode. The FFT results enable the radar to detect different vehicles simultaneously as long as the speeds are significantly different. In practice the radar only tracks one vehicle in each direction of movement. This gives the radar a significant advantage over pulse counting radars that can only track one target and the target that is tracked is the one with the largest return, which is not necessarily the nearest target to the radar.

The radar front end consists of an analogue IQ demodulator that is non-perfect in its performance. The imperfections of the IQ demodulator has the effect of when a target is detected an imaginary target is also detected that has the same speed as the real target but in the opposite direction. It is therefore necessary for the radar to check that each target is real. This is done by comparing the amplitudes of the target with its corresponding imaginary target. This filtering means that double sideband targets (like a tuning fork) are automatically filtered out as not real. This is because double sideband targets produce simulated targets that are in effect travelling in both directions at the same time. The radar has a double sideband target detect mode that can be turned. When turned on the radar will track double sideband targets and report them as having a direction of D.

The Target Detect function in addition works out the speed of the target from the FFT analysis results. The FFT result returns the Doppler frequency of a target which is further processed to give a higher accuracy measurement. This allows the radar to measure the Doppler frequency to provide results that are accurate to  $\pm 0.1$  kph.

# SYSTEM HARDWARE OVERVIEW

## TARGET TRACKING

The radar FFT target information is split into approaching, receding and double sideband targets.

The target tracking function only tracks a single target at a time so when operating in dual direction mode the function is called twice, once for each direction. If the double sideband target detection is turned on the target tracking function is called again and passed the double sideband target list. Shown below is the flow diagram for the target tracking process.

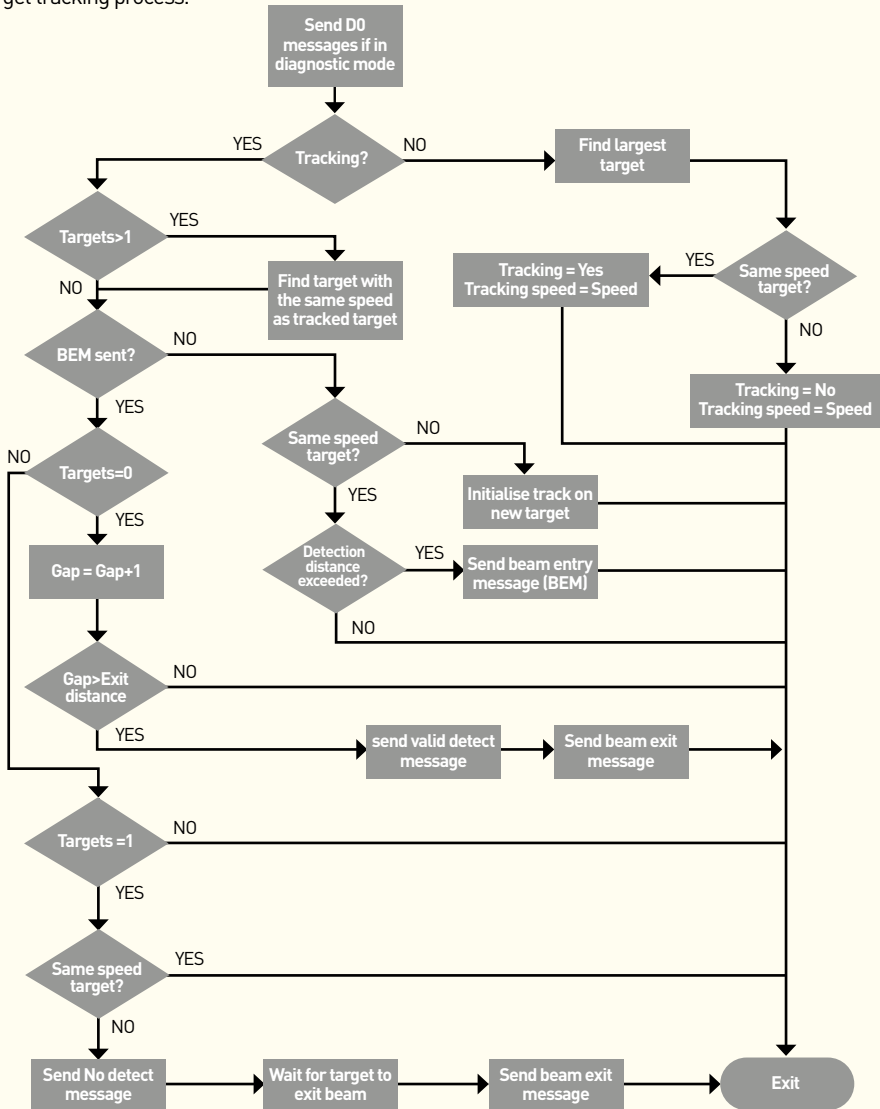

## TARGET TRACKING (CONTINUED)

---

The target tracking function will only track targets whose radar returns have exceeded a certain magnitude. This is to ensure there is enough signal to noise ratio to make a high quality speed measurement.

When there are no targets in the beam and the radar is not presently tracking a target the tracking function simply returns.

When a target first enters the radar beam the signal level will be very low. When the signal is low it is largely ignored but the radar does maintain a track history of one. If the target speed matches the previously detected target speed within a tolerance of 3kph and it has a significant magnitude then a track is started on the target. Once a track is started the radar specifically looks for the detected speed in the potential target list passed to the tracking function. When the target has been detected for a significant amount of time a beam entry message is sent. The amount of time that passes before a beam entry message is sent is proportional to the targets speed. This helps the radar to send beam entry messages when the target has reached a certain position in the beam. When the target leaves the radar beam the radar waits for a time that is proportional to the target speed before the valid detect and beam exit messages are sent. The valid detect message reports the speed measured for the vehicle when its radar return was at its maximum power. This is most likely to occur when the vehicle is in the centre of the radar beam.

In the case when a vehicle is being tracked and another vehicle enters the beam but going in the opposite direction the radar will continue to track the wanted vehicle as long as it is still in the beam. The target information for the vehicle travelling in the opposite direction will not even be passed to the tracking function as the tracking function only monitors vehicles travelling in one or the other direction.

When in dual direction mode the radar calls the tracking function twice, once for receding targets and again for approaching targets. If a vehicle travelling in the opposite direction happens to obscure the radar returns from the wanted vehicle for a significant time, the radar will assume that the wanted vehicle has exited the beam and will send a **valid detect** and a beam exit message for the wanted vehicle. This is because the tracking function is not passed the targets going in the opposite direction. In this case the tracking for the opposite direction will pick this new target up and start a new track on it. As far as the tracking for the original target is concerned the tracked vehicle has exited the beam and there are no other targets going in the same direction as the target to form a new track on.

In the case of a vehicle being tracked and another vehicle travelling in the same direction enters the beam the radar will continue to track the wanted vehicle as long as the radar can still detect returns from it. If the second vehicle is detected and its speed is not within 3kph of the first vehicle and the first vehicle has not been detected for a significant amount of time then a **non detect** message is sent. This is followed by a beam exit message when the second vehicle exits the beam. If the vehicle speeds are not significantly different, <3kph, then the vehicles appear as if they are a single target and will be tracked as normal. This may happen if the second vehicle is tail gating the first vehicle. In this case the normal beam entry, valid detect and beam exit messages will be produced as if the two targets were a single target.



# SYSTEM HARDWARE OVERVIEW

## RADAR CHARACTERISTICS

---

The radar has been designed to have a specific set of functional characteristics which make it suitable for speed measurements for enforcement applications.

### Radar Antenna

The antenna design is a planar patch array with the following performance;

Parameter	Specified	Notes
Horizontal Beam-width	4.5°	-3dB (HPBW)
Vertical Beam-width	15°	-3dB (HPBW)
Side-lobe Suppression	>15dB	
E-Field	Horizontal	Plane Polarised

### Operating Frequency Band and Power

The transmitter is a high quality Dielectric Resonator Oscillator (DRO) which has analogous aging and stability characteristics to a crystal. The design confidence means that the nominal centre frequency of the transmission shall remain within a 10MHz window for the required 7 years for a radar functioning normally.

The change in frequency with temperature is measured to be  $-250\text{KHz}/^{\circ}\text{C}$

The radar frequency and power is as follows;

Parameter	Specified	Notes
Operating Frequency Band	24.050 – 24.150 GHz (24.075 – 24.175GHz USA variant)	
Power	<100mW eirp	
Field Strength	Typically 730mV/m	At 3m
ITU Code	3M2NON	

# SYSTEM HARDWARE OVERVIEW

## RADAR PERFORMANCE

---

### Signal to Noise (Detection Range)

A series of radar techniques have been used in the 340 to maximise the signal to noise ratio for a given target. The signal to noise of the 340 is tested at manufacture by target simulation which correlates to a detection range of up to 70m.

### Speed Measurement

The speed measurement is fully instrumented over the range 20 to 300km/hr in both directions. The speed measurement is reported to the nearest 0.1km/hr and is corrected for the 22° mounting angle as its default setting. The angle can be adjusted with the appropriate command. The speed is reported in Km/hr and there is an option to convert the speed reading to mph with the appropriate command.

Measurement Frame	5.1mS	195 readings per second
Display resolution	0.1km/hr	
Processing Resolution	≤ 5 Hz	Based on post-processed FFT measurement

### Verification Accuracy

Bench Simulation	±0.2 Km/hr	20 to 300Km/Hr using single side band modulator when F0=24.100GHz
Physical and RF bore alignment	±0.31%	≤ 0.4°
Limit of F0 variation	±0.05%	-250KHz/°C assuming 24.100GHz at 20°C

### Validation Accuracy

Roadside accuracy average	±0.43% (standard deviation ±0.42%)	Typical performance based on 33 traceable readings
---------------------------	------------------------------------	--

### Frame Rate

The frame rate of the radar is fixed at 195frames/sec.

## RADAR PERFORMANCE (CONTINUED)

---

### Typical Radar Output

The following is a typical radar output for normal operation;

```
CF,000090C7*7E
01,000094D4,0000001E,A,046.5,K*2D
02,0000957A,0000001E,A,043.7,K,010.1,022.0,H*4A
04,0000957A,0000001E,A,043.7,K*28
CF,00009868*0C
01,000099BA,0000001F,A,047.1,K*55
02,00009A5B,0000001F,A,046.4,K,010.1,022.0,H*3A
04,00009A5B,0000001F,A,046.4,K*58
CF,0000A009*7B
CF,0000A7AA*75
01,0000A97F,00000020,A,052.5,K*2A
02,0000AA22,00000020,A,051.4,K,011.5,022.0,H*43
04,0000AA22,00000020,A,051.4,K*24
01,0000AE71,00000021,A,032.1,K*22
CF,0000AF4C*73
02,0000AF62,00000021,A,030.3,K,009.9,022.0,H*44
04,0000AF62,00000021,A,030.3,K*26
CF,0000B6ED*76
CF,0000BE8E*79
01,0000C489,00000022,A,045.3,K*57
02,0000C52C,00000022,A,040.3,K,008.7,022.0,H*4B
04,0000C52C,00000022,A,040.3,K*26
CF,0000C62F*02
```

# RADAR COMMANDS

## RADAR COMMAND LIST

Command	Function	Units, resolution, values and commentary	Default
<b>AGD or #AGD</b>	Reports the name of the radar and its firmware version.	AGD AGD340 Speed Enforcement Radar Firmware Version MI-096-A #AGD [STX]C2,0003A651,AGD340,MI-096-A*08[ETX]	
<b>*AD or #AD</b>	Used to enquire the radar's mounting angle setting, that is used to calculate the speed of a target.	*AD 22.00 #AD [STX]C1,0000F9EC,22.00*0F[ETX]	22.0
<b>BAUD</b>	Used to enquire/modify the baud rate used by the RS422 interface of the radar.	When the radar first boots the baud rate that is used will be reported over the RS422 interface at a baud rate of 115200. Therefore if the baud rate of the radar is not known simply use a tool like HyperTerminal and set the baud rate to 115200 to find out the baud rate of the radar. A typical output from the radar when powered up and viewed with HyperTerminal set to a baud rate of 115200 is shown below.  User configuration successfully loaded AGD340 Speed Enforcement Radar Firmware Version MI-083-L1 Baud rate = 921600 BAUD Reports the baud rate being used by the radar  BAUD x Sets the baud rate of the radar to x. When the baud rate has been set using this command the next time the radar is rebooted this is the baud rate that will be used.	115200
<b>CHECK-ADC</b>	Measures the DC offset values of the I and Q ADC channels and reports this in a C0 message.	This command is useful to perform a simple check of the analogue stages of the radar. In normal circumstances the values returned for the I and Q offsets should be in the range 8000h ± 100. Note these values are in hex. A typical radar response is as follows; CHECK-ADC [STX]C0,00001773,0000805E,00007FD4,*22[ETX]	
<b>*CRC</b>	This command responds with the 32bit CRC checksum numbers for the bios and main flash devices.	*CRC<CR> Response Bios CRC32 = EF9EE2A4 Main CRC32 = F999EAF4	
<b>*DDS or #DDS</b>	This command turns on double sideband target reporting mode.	This mode of operation of the radar will report double sideband targets which are usually simulated targets such as a tuning fork. Another common double sideband target is fluorescent lights. *DDS 0<CR> Double sideband detection off *DDS 1<CR> Double sideband detection on The #DDS command is similar but also responds with a C3 message.	0

# RADAR COMMANDS

## RADAR COMMAND LIST (CONTINUED)

Command	Function	Units, resolution, values and commentary	Default
<b>DIRECTION or #DIR</b>	Used to enquire/modify the direction mode of the radar.	DIRECTION Report the direction mode being used DIRECTION A Approaching targets mode DIRECTION R Receding targets mode DIRECTION D Dual direction mode #DIR is used in a similar way but a C4 message is sent in response.	A
<b>*DM or #DM</b>	Used to enquire/modify the diagnostic mode of the radar.	*DM Reports the diagnostic mode being used. *DM 0 Turn diagnostic mode off *DM 1 Turn diagnostic mode on In diagnostic mode the radar produces D0 messages that can be used to provide supporting evidence for an offence. However, this requires a significant baud rate to be used for reliable operation. Normally a baud rate of 115200 is sufficient. #DM is similar but also responds with a C5 message.	off
<b>*FE, #FE or FREQ_ERROR</b>	This command reports the results of the latest frequency error measurement.	*FE<CR> 49984.54Hz -11ppm 200.00MHz Passed The first frequency reported is the measured ADC clock rate. The next line reports the measured error in parts per million. Next the assumed frequency of the processor clock is reported. #FE is used in a similar way but the radar responds with a C6 message.	115200
<b>*FFD</b>	This command loads the factory set defaults from the EEPROM.	This command can be used to set the configuration to a known good state.	
<b>*HELP or ?</b>	This command is used to produce a list of the user commands.	The command does not provide information on factory commands.	
<b>LIFE</b>	Reports life time statistics of the radar.	A typical response is shown below. LIFE<CR> Time on = 1226Minutes Number of boots = 66 Valid Target detects = 489	
<b>*LS or #LS</b>	Used to enquire/modify the low speed threshold velocity of the radar.	Target speeds detected below this are not reported. This command must be passed a value of 20kph or greater. *LS Reports the present low speed threshold velocity in the presently set speed units. *LS x Sets the low speed threshold velocity to x. The units of x are in the presently set speed units (See *SU). #LS is similar but responds with a C7 message.	20kph
<b>REBOOT</b>	Performs a software reboot of the radar.		

# RADAR COMMANDS

## RADAR COMMAND LIST (CONTINUED)

Command	Function	Units, resolution, values and commentary	Default
<b>SELF-TEST</b>	This command is used to activate the radars hardware self test circuitry. The hardware can simulate both a receding target and an approaching target.	When activated the radar will turn the simulation hardware on and analysis the returning messages. If the radar measures an incorrect speed during this test or the wrong direction the radar will shut down the ADC. The usage of the SELF_TEST command is as follows SELF-TEST A      Simulate an approaching target SELF-TEST R      Simulate a receding target The self test functionality is also called during bootup.	
<b>*SL or #SL</b>	These commands are used to set the sensitivity level of the radar.	*SL                  Enquire radar sensitivity level *SL L              Set low sensitivity level. Suitable for monitoring across up to two lanes *SL H              Set high sensitivity level. Suitable for monitoring across up to four lanes The #SL is similar but responds with a C8 message.	H
<b>*SN or #SN</b>	These commands are used to enquire the radars serial number.	The *SN command just responds with the serial number of the radar. The #SN is similar to the *SN but responds with a CC message	
<b>*SU, UNITS or #SU</b>	These commands are used to enquire/modify the speed units used by the radar.	*SU                  Enquire radar speed units *SU M              Set mph as the radar speed units *SU K              Set kph as the radar speed units The #SU is similar but responds with a C9 message.	K
<b>*TGT</b>	This command tells the radar to simulate a target detect sequence.	*TGT [STX]01,00024CA5,00000001,A,100.0,K*22[STX] [STX]02,00000341,00000001,T,120.0,K,003.4,022.0,H*52[ETX] [STX]04,00024CB9,00000001,A,120.0,K*2A[ETX] The direction field of the simulated target will be T so that it cannot be mistaken for a real target. The beam entry message will always have a target speed of 100kph and the following messages will always contain a speed of 120kph. No D0 messages are simulated in this target simulation.	
<b>TEMP or #TEMP</b>	Reports the temperature of the radar in degrees Celsius	A typical response is shown below. TEMP 32.88 #TEMP is similar but responds with a CA message.	
<b>VERSION or #VER</b>	Reports the firmware version of the radar.	The #VER reports the software version in a CB message	
<b>*VN</b>	This command reports the security numbers of the DSP board.	These are unique to each DSP board and cannot be adjusted. A typical output is as follows; [STX]F0,18541854,2D392D42,3AF33AF3,55955595*50[ETX]	

## 25KHZ REFERENCE SIGNAL & THE \*FE COMMAND

---

The radar uses an analogue to digital converter, ADC, to digitise the received signals. The ADC clock source is derived from a crystal on the digitiser board that is also used for the UART. The crystal used has a frequency of 14.7456MHz. This is divided down by the CPLD by 295 to give an ADC clock frequency of 49985.08475Hz. The signal used for the ADC has a very small duty ratio that means it is difficult to measure the signals period using an oscilloscope. Therefore for measurement purposes the ADC clock is made into a square wave which requires a further division by two to give a frequency of 24992.54Hz. This signal is provided on the data connector of the radar.

To measure the reference signal output a frequency counter maybe used. The radar constantly monitors the sampling frequency by comparing how long the radar takes to collect data samples by using the processors crystal as a reference, which is independent from the ADC clock source. Measurements are compared approximately every second and if two successive measurements show a large enough error then the radar will send an error message and shut down the ADC converter. This in turn means the frame counter will longer increase in the heartbeat message. The measurement of the ADC clock frequency can be accessed at any time by using the #FE or \*FE commands.

## RADAR INTIALISATION

---

On power up or reboot of the radar the following is a typical message showing the intialisation sequence and the self test messages.

```
User configuration successfully loaded
AGD340 Speed Enforcement Radar
Firmware Version MI-096-1
Baud rate = 115200
AGD340 Speed Enforcement Radar
Firmware Version MI-096-1
01,000000CF,00000001,X,075.4,K*38
02,0000011C,00000001,X,075.4,K,007.7,022.0,H*29
04,0000011C,00000001,X,075.4,K*4B
01,000001EB,00000002,Y,075.4,K*39
02,00000238,00000002,Y,075.4,K,007.7,022.0,H*51
04,00000238,00000002,Y,075.4,K*33
CF,00000771*02
```

# MESSAGE FORMATS

## RADAR EVENT MESSAGES

### Standard message

The radar in normal operation produces four standard messages. Each message type is identified by the MT field, see diagram below. The four message types are:

- 01 Beam entry message
- 02 Valid detect message
- 03 No detect message
- 04 Beam exit message

The numbers above the boxes in Figure 5 indicate how many bytes are used for each field.

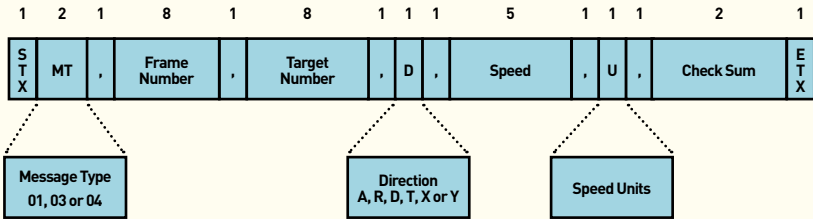

### Format for 01, 03 & 04 messages

Name	Size / Bytes	Value	Notes
STX	1	2	Start of message byte
MT	2	'01'=Beam Entry '03'=No Detect '04'=Beam exit	Message type
,	1	','	Comma
Frame Number	8	XXXXXXXX	Frame number in hexadecimal format
,	1	','	Comma
Target Number	8	XXXXXXXX	Target identification number in hexadecimal format
,	1	','	Comma
Direction	1	'A'=Approaching Target 'R'=Receding Target 'D'=Double sideband target 'T'=Simulated Test Target 'X'=Simulated approaching target 'Y'=Simulated receding target	Direction the target is travelling.
,	1	','	Comma
Speed	5	'DDD.D'	Target speed to one decimal place in decimal format
,	1	','	Comma
Speed Units	1	'M'=mph 'K'=kph	The speed units used for the measurement
*	1	'*'	Asterisk
Check Sum	2	'XX'	Check sum in hexadecimal format
ETX	1	3	End of message byte



# MESSAGE FORMATS

## RADAR EVENT MESSAGES (CONTINUED)

### Format for 02 message

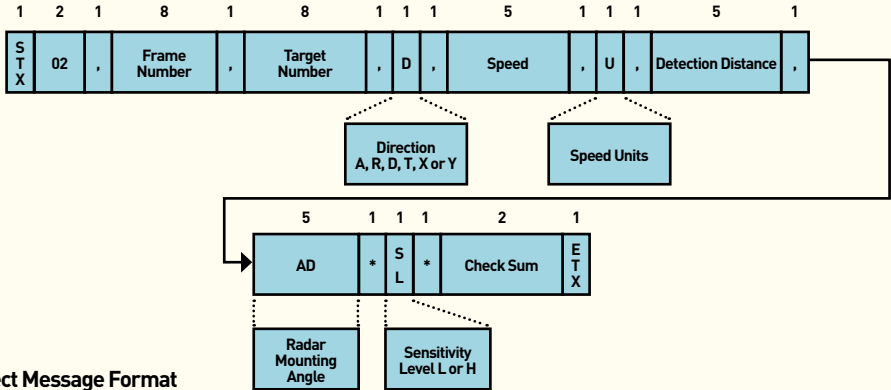

### Valid Detect Message Format

Name	Size / Bytes	Value	Notes
STX	1	2	Start of message byte
MT	2	'02'=Valid detect	Message Type
,	1	','	Comma
Frame Number	8	XXXXXXXX	Frame number in hexadecimal format
,	1	','	Comma
Target Number	8	XXXXXXXX	Target identification number in hexadecimal format
,	1	','	Comma
Direction	1	'A'=Approaching Target 'R'=Receding Target 'D'=Double sideband target 'T'=Simulated Test Target 'X'=Simulated approaching target 'Y'=Simulated receding target	Direction the target is travelling.
,	1	','	Comma
Speed	5	'DDD.D'	Target speed to one decimal place in decimal format
,	1	','	Comma
U	1	'M'=mph 'K'=kph	The speed units used for the measurement
,	1	','	Comma
Detection Distance	5	'DDD.D'	The distance a target has travelled during detection in metres
,	1	','	Comma
AD	5	'DDD.D'	Radar mounting angle in degrees to an accuracy of one decimal place in decimal format. This is the angle the radar uses to calculate the speed of a target
,	1	','	Comma
SL	1	'L'=Low 'H'=High	Sensitivity level the radar is set to
*	1	'*'	Asterisk
Check Sum	2	'XX'	Check sum in hexadecimal format
ETX	1	3	End of message byte

# MESSAGE FORMATS

## RADAR EVENT MESSAGES (CONTINUED)

---

### Valid Detect Message Format (cont.)

The radar counts time in frames. The time the message is sent is stored in the frame number field in hexadecimal format.

Each new target detected is given a new target number that is stored in the field target number in hexadecimal format.

The direction field can either be A for approaching or R for receding. When the radar is operating in double sideband detect mode the direction can also be D to indicate a double sideband target detection.

The speed of the target is given to 1 decimal place. The units used are supplied in the U field. K signifies kph while M indicates mph.

The check sum value is calculated by performing an XOR on all the characters starting with the first byte of the MT field and up to but not including the checksum characters. The checksum is output as a 2 character hexadecimal number.

### Diagnostic Messages

These messages are not produced as standard and are normally disabled. The \*DM command has to be sent to the radar to enable them.

### D0 Message

The D0 messages are enabled by using the \*DM command. When followed with a 1 the D0 messages are enabled and disabled by following with a 0, e.g.

\*DM 1 Turn D0 messages on

\*DM 0 Turn D0 messages off

The D0 message format is shown below.

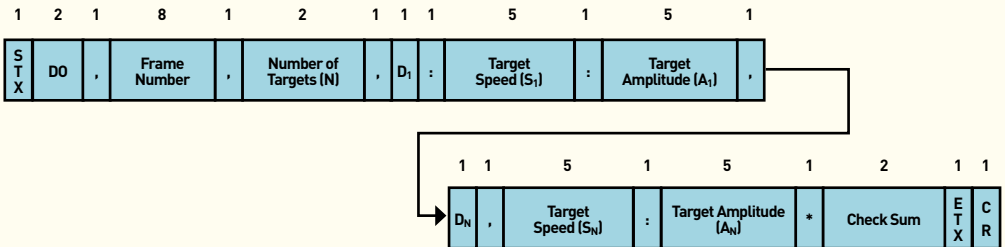

# MESSAGE FORMATS

## RADAR EVENT MESSAGES (CONTINUED)

### Diagnostic message format

Name	Size / Bytes	Value	Notes
<b>STX</b>	1	2	Start of message byte
<b>MT</b>	2	'D0'=Debug message	Message Type
,	1	','	Comma
<b>Frame Number</b>	8	XXXXXXXX	Frame number in hexadecimal format
,	1	','	Comma
<b>Number of targets</b>	2	XX	Number of targets being reported
,	1	','	Comma
<b>D<sub>1</sub></b>	1	'A' = Approaching Target 'R' = Receding Target 'D' = Double sideband target 'X' = Simulated approaching target 'Y' = Simulated receding target	Direction the 1st target is travelling.
:	1	':'	Colon separator
<b>Target Speed S<sub>1</sub></b>	5	'DDD.D'	Target speed in kph to one decimal place in decimal format of 1st target
:	1	':'	Colon separator
<b>Target Amplitude A<sub>1</sub></b>	5	'DDD.D'	Amplitude of 1st target in dB
,	1	','	Comma
.	.	.	.
<b>D<sub>N</sub></b>	1	'A'=Approaching Target 'R'=Receding Target 'D'=Double sideband target	Direction the nth target is travelling.
:	1	':'	Colon separator
<b>Target Speed S<sub>N</sub></b>	5	'DDD.D'	Target speed in kph to one decimal place in decimal format of nth target
:	1	':'	Colon separator
<b>Target Amplitude A<sub>N</sub></b>	5	'DDD.D'	Amplitude of nth target in dB
*	1	'*'	Asterisk
<b>Check Sum</b>	2	'XX'	Check sum in hexadecimal format
<b>ETX</b>	1	3	End of message byte

The D0 messages contain the output of the target detection function. The D0 message lists all the potential targets the radar has detected for the mode the radar is working in. When the radar is operating in this mode large amounts of data need to be transferred over the RS422 interface. D0 messages during a target detect will typically be produced at a rate of 195 per second. Therefore a baud rate of at least 115200 is required to support this mode of operation.

D0 messages contain a lot of information about the track history of a target as it travels through the beam. The D0 messages could be used to provide extra evidence about any particular speeding offence. For instance the diagram on the following shows a typical D0 sequence for a vehicle approaching the radar:

# MESSAGE FORMATS

## RADAR EVENT MESSAGES (CONTINUED)

Typical D0 data plotted

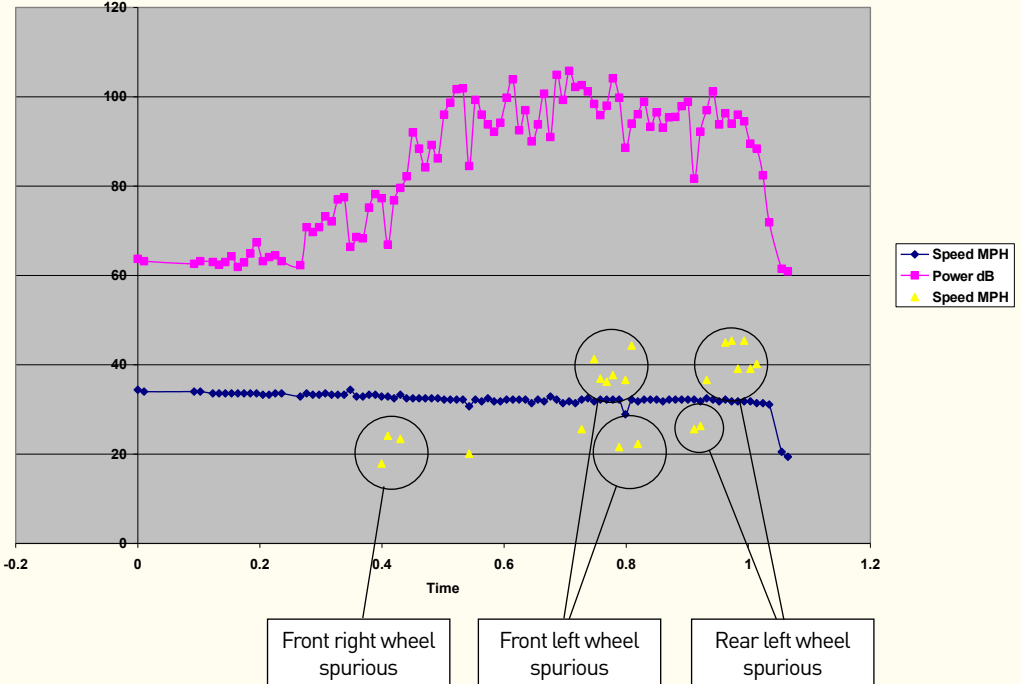

As can be seen from diagram above the vehicle speed can easily be picked out from any spurious signals caused by the wheels of the vehicle. The wheels of a vehicle can produce spurious speeds which can vary between 0 and twice the actual speed of the vehicle. However because the wheel spurious signals are not consistent a track is never formed on them. The speed reported by the radar in the valid detect and beam exit messages will be the one associated with the largest magnitude detected.

# MESSAGE FORMATS

## RADAR STATUS MESSAGES

### CO message

The CO message is produced in response to the CHECK-ADC command. The message format is shown below.

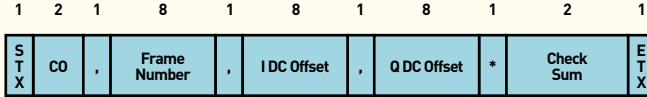

### CO message format

Name	Size / Bytes	Value	Notes
STX	1	2	Start of message byte
MT	2	'CO'	Message type
,	1	','	Comma
Frame Number	8	XXXXXXXX	Frame number in hexadecimal format
,	1	','	Comma
I DC Offset	8	XXXXXXXX	I channel DC offset in hexadecimal format
,	1	','	Comma
Q DC Offset	8	XXXXXXXX	Q channel DC offset in hexadecimal format
*	1	'*'	Asterisk
Check Sum	2	'XX'	Check sum in hexadecimal format
ETX	1	3	End of message byte

### C1 Mounting Angle Message

This message is sent in response to a #AD command. The message reports the mounting angle the radar is using to calculate the speed of vehicles. The message format is shown below.

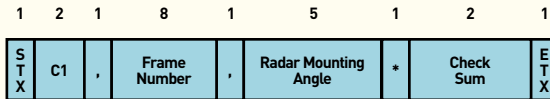

### C1 Mounting Angle Message format

Name	Size / Bytes	Value	Notes
STX	1	2	Start of message byte
MT	2	'C1'	Message type
,	1	','	Comma
Frame Number	8	XXXXXXXX	Frame number in hexadecimal format
,	1	','	Comma
Radar Mounting Angle	5	DD.DD	Radar mounting angle in degrees
*	1	'*'	Asterisk
Check Sum	2	'XX'	Check sum in hexadecimal format
ETX	1	3	End of message byte

# MESSAGE FORMATS

## RADAR STATUS MESSAGES

### C2 message

This message is sent in response to a #AGD command. The message reports the radar type and firmware version. The message format is shown below.

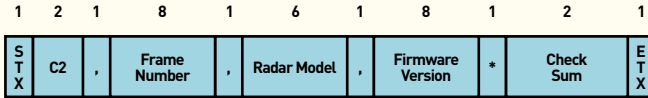

### C2 message format

Name	Size / Bytes	Value	Notes
STX	1	2	Start of message byte
MT	2	'C2'	Message type
,	1	','	Comma
Frame Number	8	XXXXXXXX	Frame number in hexadecimal format
,	1	','	Comma
Radar Model	6	AGD340	Radar type
,	1	','	Comma
Firmware Version	8	'MI-DDD-A'	Firmware version
*	1	'*'	Asterisk
Check Sum	2	'XX'	Check sum in hexadecimal format
ETX	1	3	End of message byte

### C3 DDS mode Message

This message is sent in response to a #DDS command. The message format is shown below.

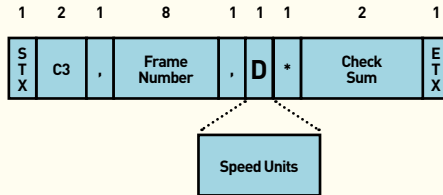

### C3 DDS message format

Name	Size / Bytes	Value	Notes
STX	1	2	Start of message byte
MT	2	'C3'	Message type
,	1	','	Comma
Frame Number	8	XXXXXXXX	Frame number in hexadecimal format
,	1	','	Comma
DDS Mode	1	'0' = Off '1' = On	DDS mode
*	1	'*'	Asterisk
Check Sum	2	'XX'	Check sum in hexadecimal format
ETX	1	3	End of message byte

# MESSAGE FORMATS

## RADAR STATUS MESSAGES

### C4 Direction mode message

This message is sent in response to a #DIR command.

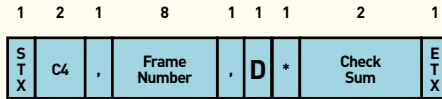

Direction Mode  
A=Approaching  
R=Receding  
D= Dual Direction

### C4 Direction mode message format

Name	Size / Bytes	Value	Notes
STX	1	2	Start of message byte
MT	2	'C4'	Message type
,	1	','	Comma
Frame Number	8	XXXXXXXX	Frame number in hexadecimal format
,	1	','	Comma
Direction Mode	1	'A' = Approaching 'R' = Receding 'D' = Dual Direction	Direction mode of radar
*	1	'*'	Asterisk
Check Sum	2	'XX'	Check sum in hexadecimal format
ETX	1	3	End of message byte

### C5 Debug mode message

This message is sent in response to a #DM command.

The message format is shown right.

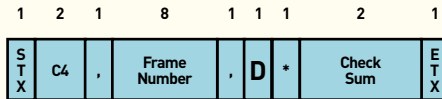

Debug Mode  
0 = Off  
1 = On

### C5 Debug mode message format

Name	Size / Bytes	Value	Notes
STX	1	2	Start of message byte
MT	2	'C5'	Message type
,	1	','	Comma
Frame Number	8	XXXXXXXX	Frame number in hexadecimal format
,	1	','	Comma
Debug Mode	1	'0' = Off '1' = On	Debug mode of radar
*	1	'*'	Asterisk
Check Sum	2	'XX'	Check sum in hexadecimal format
ETX	1	3	End of message byte

# MESSAGE FORMATS

## RADAR STATUS MESSAGES

### C6 Frequency error message

This message is sent in response to a #FE command. The message reports the ADC sampling frequency measured by the processor and the ADC sampling frequency error. The message format is shown below.

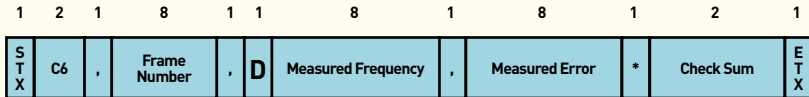

### C6 Frequency error message format

Name	Size / Bytes	Value	Notes
STX	1	2	Start of message byte
MT	2	'C6'	Message type
,	1	','	Comma
Frame Number	8	XXXXXXXX	Frame number in hexadecimal format
,	1	','	Comma
Measured Frequency	8	'DDDD.DD'	Measured ADC sampling frequency in decimal
,	1	','	Comma
Measured Error	5	DDDDDDDD	ADC frequency error in parts per million
*	1	'*'	Asterisk
Check Sum	2	'XX'	Check sum in hexadecimal format
ETX	1	3	End of message byte

### C7 Low speed threshold message

This message is sent in response to a #LS command. The message reports the low speed threshold being used by the radar and the units the radar is using. The message format is shown right.

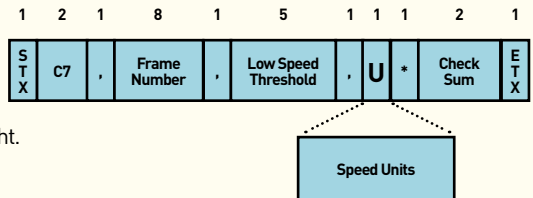

### C7 Low speed threshold message format

Name	Size / Bytes	Value	Notes
STX	1	2	Start of message byte
MT	2	'C7'	Message type
,	1	','	Comma
Frame Number	8	XXXXXXXX	Frame number in hexadecimal format
,	1	','	Comma
Low Speed Threshold	8	DDDDD	
,	1	','	Comma
Speed Units	5	'M'=mph 'K'=kph	Speed units being used
*	1	'*'	Asterisk
Check Sum	2	'XX'	Check sum in hexadecimal format
ETX	1	3	End of message byte



# MESSAGE FORMATS

## RADAR STATUS MESSAGES

### C8 Sensitivity level message

This message is sent in response to a #SL command. The message format is shown right.

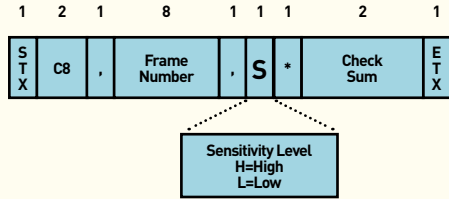

### C8 Sensitivity level message format

Name	Size / Bytes	Value	Notes
STX	1	2	Start of message byte
MT	2	'C8'	Message type
,	1	','	Comma
Frame Number	8	XXXXXXXX	Frame number in hexadecimal format
,	1	','	Comma
S	1	'H' = High 'L' = Low	Radar sensitivity mode
*	1	'*'	Asterisk
Check Sum	2	'XX'	Check sum in hexadecimal format
ETX	1	3	End of message byte

### C9 Speed units message

This message is sent in response to #SU command. The message format is shown right.

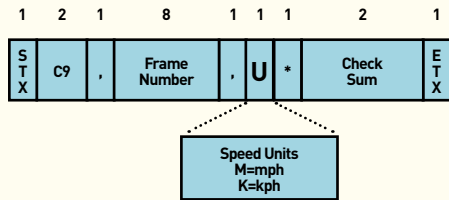

### C9 Speed units message format

Name	Size / Bytes	Value	Notes
STX	1	2	Start of message byte
MT	2	'C9'	Message type
,	1	','	Comma
Frame Number	8	XXXXXXXX	Frame number in hexadecimal format
,	1	','	Comma
Speed Units	1	'M' = mph 'K' = KHP	Speed units being used
*	1	'*'	Asterisk
Check Sum	2	'XX'	Check sum in hexadecimal format
ETX	1	3	End of message byte

# MESSAGE FORMATS

## RADAR STATUS MESSAGES

### CA Temperature message

This message is sent in response to a #TEMP command. The message reports the temperature of the radar as measured by a sensor on the digitiser board. The message format is shown right.

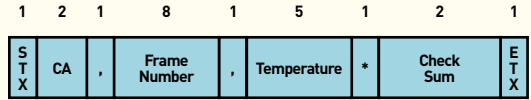

### CA Temperature message format

Name	Size / Bytes	Value	Notes
STX	1	2	Start of message byte
MT	2	'CA'	Message type
,	1	','	Comma
Frame Number	8	XXXXXXXX	Frame number in hexadecimal format
,	1	','	Comma
Temperature	1	DD.DD	Radar temperature in degrees
*	1	'*'	Asterisk
Check Sum	2	'XX'	Checksum in hexadecimal format
ETX	1	3	End of message byte

### CB Firmware version message

This message is sent in response to a #VER command. The message format is shown below.

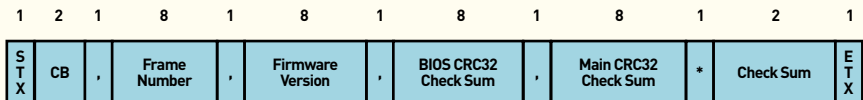

### CB Firmware version message format

Name	Size / Bytes	Value	Notes
STX	1	2	Start of message byte
MT	2	'CB'	Message type
,	1	','	Comma
Frame Number	8	XXXXXXXX	Frame number in hexadecimal format
,	1	','	Comma
Firmware Version	8	'MI-DDD-A'	Firmware version
,	1	','	Comma
BIOS CRC32 Check Sum	8	XXXXXXXX	BIOS flash checksum value
,	1	','	Comma
Main CRC32 Check Sum	8	XXXXXXXX	Main flash checksum value
*	1	'*'	Asterisk
Check Sum	2	'XX'	Checksum in hexadecimal format
ETX	1	3	End of message byte

# MESSAGE FORMATS

## RADAR STATUS MESSAGES

### CC Serial number message

This is the serial number message. This message is sent in response to the #SN command.

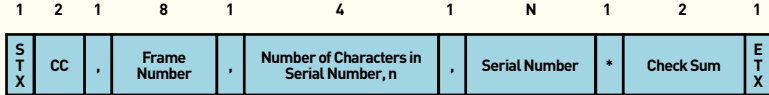

### CC Serial number message format

Name	Size / Bytes	Value	Notes
STX	1	2	Start of message byte
MT	2	'CA'	Message type
,	1	','	Comma
Frame Number	8	XXXXXXXX	Frame number in hexadecimal format
,	1	','	Comma
Number of characters in serial number	1	XXXXXXXX	Number of characters in serial number, N
,	1	','	Comma
Serial Number		ASCII String	Serial number string
*	1	'*'	Asterisk
Check Sum	2	'XX'	Checksum in hexadecimal format
ETX	1	3	End of message byte

### CF Heartbeat message

This message is sent in response to a #VER command. The message format is shown below.

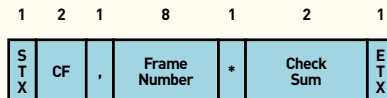

### CF Heartbeat message format

Name	Size / Bytes	Value	Notes
STX	1	2	Start of message byte
MT	2	'CF'	Message type
,	1	','	Comma
Frame Number	8	XXXXXXXX	Frame number in hexadecimal format
*	1	'*'	Asterisk
Check Sum	2	'XX'	Checksum in hexadecimal format
ETX	1	3	End of message byte

# MESSAGE FORMATS

## RADAR ERROR MESSAGES

### EO message

The EO message is used to report errors detected in the radar. The format of this message is shown below.

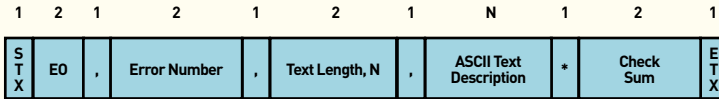

### EO message format

Name	Size / Bytes	Value	Notes
STX	1	2	Start of message byte
MT	2	'EO'	Message type
,	1	','	Comma
Error Number	2	XX	2 Digit error number in hexadecimal format
,	1	','	Comma
Text length, N		XX	2 Digit hexadecimal number indicating the length of the text description
,	1	','	Comma
Text Description	5	"Some text string"	Text string of length N
,	1	'*'	Asterisk
Check Sum	2	'XX'	Check sum in hexadecimal format
ETX	1	3	End of message byte

## ANTENNA PLOTS

---

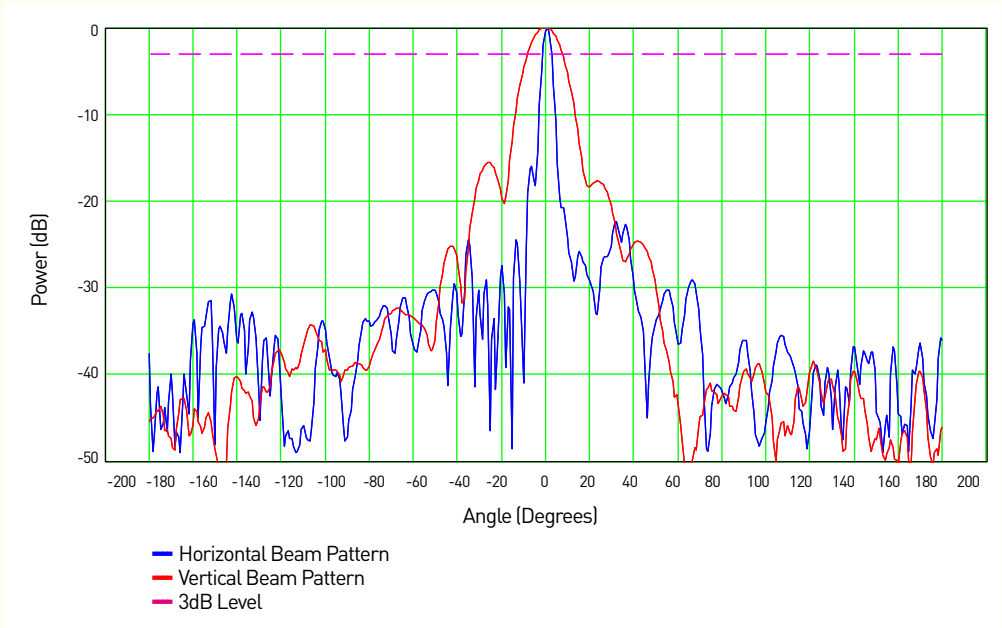

# TECHNICAL SPECIFICATIONS

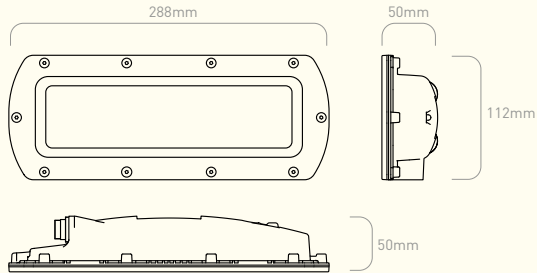

## SPECIFICATIONS

<b>Technology</b>	CW Doppler Radar
<b>Frequency</b>	24.050 to 24.150GHz (see option 1)
<b>Beam Width (HPBW)</b>	Horizontal 4.5 degrees Vertical 15 degrees
<b>Radiated Power</b>	<100mW EIRP
<b>Mounting</b>	Flange Fixings or Tripod mount
<b>Mounting Height</b>	1 - 3.5m nominal
<b>Measurement Angle</b>	22 degrees
<b>Speed Detection Range</b>	20 - 300 kph
<b>Displacement Distance</b>	>1m
<b>Supply</b>	9 - 30 V dc (power cables must be less than 3m)
<b>Current</b>	170mA (12V dc)
<b>Weight</b>	800g
<b>Housing Material</b>	Polycarbonate
<b>Housing Finish</b>	Self-coloured black
<b>Sealing</b>	IP66
<b>Operating Temperature</b>	-20° C to +60° C
<b>Output</b>	RS422
<b>EMC Specification</b>	EN 301-489/BS EN 50293
<b>Radio Specification</b>	ETSI 300.440 / FCC CFR47 Part 15.245 AS/NZS 4268
<b>Highest Temp Humidity Combination</b>	50°C 80%

## OPTIONS

1. Frequency option can be preset to suit local requirements between 24.000GHz and 24.250GHz



Restriction on Hazardous Substances

Owing to the Company's policy of continuous improvement, AGD Systems Limited reserves the right to change their specification or design without notice.

## DEDICATED TEST EQUIPMENT



---

The key test functions performed by Triton to Certify the premium performance of the 340 are:

- Full target speed simulation traceable to a National Standard >400kph
- Certified speed range 20-300kph
- Simulated speed accuracy <100ppm
- Optimisation of frequency signals
- Transmitted radar power and frequency measurement
- Target image rejection optimisation
- Radar signal to noise level measurement
- >15hr hour burn-in
- Test cycle time 9 minutes



# MANUFACTURING TEST PROCESS

	TEST EQUIPMENT:	<b>TRITON™</b>	
	PRODUCT TEST:	340   344	
	TEST FUNCTION:	<ul style="list-style-type: none"> <li>• Full enforcement speed simulation</li> <li>• Certified speed range 20-300 kph</li> <li>• Simulated speed accuracy &lt;100ppm</li> <li>• Test cycle time 9 minutes</li> </ul>	



**Triton™** is a bespoke set of test equipment designed and developed by AGD Systems. It is dedicated to the testing of the 340 speed enforcement radar detector range and 100% of these units manufactured at AGD are Certified by Triton.

The key test functions performed by Triton to Certify the premium performance of your Intelligent Detection System are:

- Full target speed simulation traceable to a National Standard >400kph
- Certified speed range 20-300kph
- Simulated speed accuracy <100ppm
- Optimisation of frequency signals
- Transmitted radar power and frequency measurement
- Target image rejection optimisation
- Radar signal to noise level measurement
- >15hr hour burn-in
- Test cycle time 9 minutes

The AGD designed full enforcement radar target simulator which forms part of the Triton test equipment enables reliable simulation of the complete enforcement range of vehicle speeds in rapid succession during the test process. This provides full control of simulated targets' signal size, speed and direction.

The Triton test cycle provides a certified speed range of 20-300kph with a simulated speed accuracy of less than 100ppm.



# ACCURATE

The Triton test cycle provides a certified speed range of 20-300kph with a simulated speed accuracy of less than 100ppm

Optimisation of frequency signals on Triton ensures full compatibility with different country requirements within the 24GHz radar operating band.

## LIFETIME PRODUCT TRACEABILITY

There are clearly defined pass and fail criteria at all stages within the Triton test process. The test results in association with the product build revision are recorded on a product serial number basis. The full suite of test measurements is instantly sent to the dedicated product database within the AGD secure server facility, providing full traceability during the product lifetime.

The AGD Certified symbol is your mark of assured performance.



## SAFETY PRECAUTIONS

---

All work must be performed in accordance with company working practices, in-line with adequate risk assessments. Only skilled and instructed persons should carry out work with the product. Experience and safety procedures in the following areas may be relevant:

- Working with mains power
  - Working with modern electronic/electrical equipment
  - Working at height
  - Working at the roadside or highways
1. This product is compliant to the Restriction of Hazardous Substances (RoHS - European Union directive 2011/65/EU).
  2. Should the product feature user-accessible switches, an access port will be provided. Only the specified access port should be used to access switches. Only non-conductive tools are to be used when operating switches.
  3. The product must be correctly connected to the specified power supply. All connections must be made whilst the power supply is off or suitably isolated. Safety must always take precedence and power must only be applied when deemed safe to do so.
  4. No user-maintainable parts are contained within the product. Removing or opening the outer casing is deemed dangerous and will void all warranties.
  5. Under no circumstances should a product suspected of damage be powered on. Internal damage may be suggested by unusual behaviour, an unusual odour or damage to the outer casing. Please contact AGD for further advice.



## IMPORTANT INFORMATION

### Low Power Non-Ionising Radio Transmission and Safety

Concern has been expressed in some quarters that low power radio frequency transmission may constitute a health hazard. The transmission characteristics of low power radio devices is a highly regulated environment for the assurance of safe use.

There are strict limits on continuous emission power levels and these are reflected in the testing specifications that the products are approved to. These type approval limits are reflected in the product specifications required for a typical geographic area such as those for the EU (ETS300:440), for the USA (FCC part 15c) and for Australia/ New Zealand (AS/NZS 4268). The limits adopted in these specifications are typically replicated in many other localized specifications.

The level of safe human exposure to radio transmission is given by the generally accepted guidelines issued by the International Commission on Non-Ionizing Radiation Protection (ICNIRP). This body has issued guidance for limiting exposure to time-varying electric, magnetic and electromagnetic fields (up to 300 GHz) which are quoted below.

	Radar and ICNIRP limit comparison			Typical Informative Limits for Radar Transmission Approval		
	Radar Transmitted Level (Note 4)	ICNIRP Limit (Table 6)	Exposure Margin	ETS300:440	FCC (part15c)	AS/NZS 4268
Power (mW EIRP)	<100mW (<20dBm)	N/A	N/A	100mW (20dBm)	1875mW (Note 1)	100mW (20dBm)
Max Power Density (mW/cm <sup>2</sup> )	3.18μW/cm <sup>2</sup> at 50cm (Note 3)	<50W/m <sup>2</sup> (5mW/cm <sup>2</sup> ) (Note 2)	0.064%	N/A	N/A	N/A
Field Strength (V/m) at 3m	<0.58V/m (5.8mV/cm) (Note 1)	<137V/m (1370mV/cm)	0.42%	0.58V/m (5.8mV/cm) (Note 1)	2500mV/m (25mV/cm)	0.58V/m (5.8mV/cm) (Note 1)

*Note 1 Values are calculated conversions for comparison purposes.*

*Note 2 Other equivalent limits include; Medical Research Council Limit of 10mW/cm<sup>2</sup>, IACP limit of 5mW/cm<sup>2</sup> (at 5cm) and UK CAST limit of 5mW/cm<sup>2</sup>*

*Note 3 Calculation is made on the assumption antenna is a point source therefore the actual value is likely to be significantly less than that quoted. Note that a theoretical max level at a 5cm distance (which gives 0.318mW/cm<sup>2</sup>) is at a point in the field where the radar beam is not properly formed.*

*Note 4 Comparison for product model 340 operating in the band typically 24.050GHz to 24.250GHz*

From the table it can be seen that it is extremely unlikely that a potentially hazardous situation could occur owing to the use of such low power devices.

It is considered to be good practice not to subject humans to radiation levels higher than is necessary. In a works environment where multiple equipment on soak test are to be encountered then it is considered good practice to contain the equipment in an appropriate enclosure lined with radar absorbing material.



Report Number: EL4304-11664  
 Issue: 1  
 Copy Number: PDF

**REPORT ON THE EMC TESTING OF A  
 AGD Systems Ltd.  
 AGD 340  
 WITH RESPECT TO SPECIFICATION  
 EN301-489-3 v1.4.1 (2002-08) using the common technical requirements of EN301-489-1 v1.6.1  
 (2005-09)**

TEST DATE: 29th - 31st October and 10th - 11th November 2008

Tested By: *B. Standham*  
 B. Standham  
 Digitally signed by Barry Standham  
 Reason: I am the author of this document  
 Date: 2008.01.08 16:04:20 Z

Approved By: *N. Roche*  
 Neil Roche  
 Digitally signed by Neil Roche  
 Reason: I am approving this document  
 Date: 2008.01.08 16:11:14 Z

Date: 8<sup>th</sup> January 2009

Distribution:  
 Copy 1: TRL Compliance Ltd.  
 Copy 2: AGD Systems Ltd.

Disclaimers:  
 (1) THIS DOCUMENT MAY BE REPRODUCED ONLY IN ITS ENTIRETY AND WITHOUT CHANGE  
 (2) THE RESULTS CONTAINED IN THIS DOCUMENT RELATE ONLY TO THE TRADER TESTED.



100 Frobisher Business Park, Leigh Sinton Rd, Malvern, Worcs, WR14 1BX, UK.  
 T +44 (0) 1684 571700  
 F +44 (0) 1684 571701  
 E test@trlcompliance.com



Submission No. > 131458

**TECHNICAL ACCEPTANCE  
 CERTIFICATE**

**CERTIFICAT D'APPROBATION  
 TECHNIQUE**

CERTIFICATION No. / No. DE CERTIFICATION > 7907A-AGD340  
 ISSUED TO / DELIVRE A > AGD SYSTEMS LTD  
 TYPE OF EQUIPMENT / GENRE DE MATERIEL > Vehicle Speed Radar  
 TRADE NAME AND MODEL / MARQUE ET MODELE > AGD340

FREQUENCY RANGE / BANDE DE FREQUENCES	EMISSION TYPE / GENRE D'EMISSIION	R.F. POWER / PUISSANCE H.F.	SPECIFICATION/ ISSUE / SPECIFICATION/ EDITION
24.0975 GHz	3M21N0N	RSS210	7

Certification of equipment means only that the equipment has met the requirements of the above noted specifications. Licence applications, where applicable to use certified equipment, are acted on accordingly by the issuing officer and will depend on the existing radio environment, service and location of operation.

L'homologation de matériel signifie seulement qu'il est conforme aux exigences du cadre des charges mentionnées ci-dessus. Les demandes de licence, le cas échéant en vue de l'utilisation de matériel certifié seront traitées en conséquence par le bureau chargé de délivrer les licences, en tenant compte du milieu radioélectrique ambiant, du service radio existant et de l'emplacement de la station.

This certificate is issued on condition that the holder complies and will continue to comply with the requirements of the radio standards specifications and procedures issued by the Department.

Le présent certificat est délivré à la condition que le détenteur se conforme et continue à se conformer aux exigences des charges et procédures publiées par le ministère.

ISSUED UNDER THE AUTHORITY OF MINISTER OF INDUSTRY  
 DELIVRE AVEC L'AUTORISATION DU MINISTRE DE L'INDUSTRIE

DATE February 16 2009

FOR

Nicolas DesMarais  
 DIRECTOR GENERAL / DIRECTEUR GENERAL  
 SPECTRUM ENGINEERING / GENIE DU SPECTRE



# CERTIFICATION



**TRL Compliance**  
part of TRAC global

CERTIFICATE OF CONFORMITY & COMPLIANCE

FCC IDENTITY: WH3AGD340  
 PURPOSE OF TEST: Certification  
 TEST SPECIFICATION: FCC RULES CFR 47, Part 15.245 September 2007  
 TEST RESULT: Compliant to Specification  
 EQUIPMENT UNDER TEST: AGD340  
 ITU-EMISSION CODE: 3M2NON  
 EQUIPMENT TYPE: Portable Non Handheld Radar  
 PRODUCT USE: Enforcement Radar  
 CARRIER EMISSION: 727.779 mV/m @ 3m  
 ANTENNA TYPE: Integral  
 ALTERNATIVE ANTENNA: Not Applicable  
 BAND OF OPERATION: 24.075 – 24.175 GHz  
 CHANNEL SPACING: Not Applicable, Wideband  
 NUMBER OF CHANNELS: 1  
 FREQUENCY GENERATION: SAW Resonator  Crystal  Synthesiser   
 MODULATION METHOD: Amplitude  Digital  Angle   
 POWER SOURCE(s): 12Vdc / 24Vac  
 TEST DATE(s): 28<sup>th</sup> April – 4<sup>th</sup> August 2008  
 ORDER No(s): 39327  
 APPLICANT: AGD Systems Ltd

ADDRESS: White Lion House  
 Gloucester Road  
 Staverton  
 Cheltenham  
 Gloucester  
 GL51 0TF

Daniel  
 Winstanley

Digitally signed by Daniel Winstanley  
 DN: cn = Daniel Winstanley, c = GB,  
 Reason: I am the author of this  
 document.  
 Date: 2008.08.08 15:01:17 +0100

TESTED BY:

APPROVED BY:

RU1432/8707



**TRL Compliance**  
part of TRAC global

CERTIFICATE OF CONFORMITY & COMPLIANCE

PURPOSE OF TEST: Radio Performance Testing  
 TEST SPECIFICATION(s): ETSI EN300 440-2V1.1.2:07-2004  
 TEST RESULT: Compliant to Specification  
 EQUIPMENT UNDER TEST: AGD340  
 BAND(s) OF OPERATION: EU 24.00 GHz – 24.25 GHz  
 UK 24.05 GHz – 24.15 GHz  
 EQUIPMENT TYPE: Field Disturbance Centre  
 EQUIPMENT USE: Portable Non Handheld Enforcement Radar  
 TRANSMITTER Power: 90.36 mW e.i.r.p.  
 TRANSMITTER POWER CLASS: Class 11  
 ANTENNA TYPE: Patch Antenna  
 CHANNEL SPACING: Wideband  
 NUMBER OF CHANNELS: 1  
 FREQUENCY GENERATION: SAW Resonator  Crystal  Oscillator   
 MODULATION METHOD: Amplitude  Digital  Angle   
 POWER SOURCE(s): Nominal +12Vdc (9-30Vdc / 24Vac)  
 RECEIVER CLASS: Class 2  
 TEST DATE(s): 28<sup>th</sup> April – 4<sup>th</sup> August 2008  
 ORDER No(s): 39327  
 APPLICANT: AGD Systems Ltd

Daniel  
 Winstanley

Digitally signed by Daniel Winstanley  
 DN: cn = Daniel Winstanley, c = GB,  
 Reason: I am the author of this  
 document.  
 Date: 2008.08.03 11:08:48 +0100

D WINSTANLEY

TESTED BY:

APPROVED BY:

John Charters

Digitally signed by John Charters  
 Reason: I am approving this  
 document.  
 Date: 2008.08.03 12:00:09 +0100

J CHARTERS  
 RADIO SECTION  
 LEADER

RU1432/8708





PURPOSE OF TEST:	Radio Performance Testing
TEST SPECIFICATION(s):	AS/NZS 4208:2003
TEST RESULT:	Compliant to Specification
EQUIPMENT UNDER TEST:	AGD340
BAND(s) OF OPERATION:	24.00 GHz – 24.25 GHz
EQUIPMENT TYPE:	Field Disturbance Centre
EQUIPMENT USE:	Portable Non Handheld Enforcement Radar
TRANSMITTER Power:	90.36 mW e.i.r.p.
ANTENNA TYPE:	Patch Antenna
CHANNEL SPACING:	Wideband
NUMBER OF CHANNELS:	1
FREQUENCY GENERATION:	SAW Resonator <input type="checkbox"/> Crystal <input type="checkbox"/> Oscillator <input checked="" type="checkbox"/>
MODULATION METHOD:	Amplitude <input checked="" type="checkbox"/> Digital <input type="checkbox"/> Angle <input type="checkbox"/>
POWER SOURCE(s):	Nominal +12Vdc (9-30Vdc / 24Vac)
TEST DATE(s):	28 <sup>th</sup> April – 4 <sup>th</sup> August 2008
ORDER No(s):	39327
APPLICANT:	AGD Systems Ltd
TESTED BY:	<p><b>Daniel Winstanley</b></p> <p><i>[Signature]</i></p> <p>Digitally signed by Daniel Winstanley DN: cn = Daniel Winstanley, c = gb email = [redacted], serial = 101 Date: 2008.08.15 08:57:27 +0100</p> <p>D WINSTANLEY</p>
APPROVED BY:	<p><i>[Signature]</i></p> <p>Digitally signed by John Charters DN: cn = John Charters, c = GB, o = TRL Compliance Ltd, email = [redacted] Date: 2008.08.21 14:42:41 +0100</p> <p>J CHARTERS RADIO SECTION LEADER</p>

RU1432/8700







# DISCLAIMER

While we (AGD Systems) endeavour to keep the information in this manual correct at the time of print, we make no representations or warranties of any kind, express or implied, about the completeness, accuracy, reliability, suitability or availability with respect to the information, products, services, or related graphics contained herein for any purpose.

Any reliance you place on such information is therefore strictly at your own risk. In no event will we be liable for any loss or damage including without limitation, indirect or consequential loss or damage, or any loss or damage whatsoever arising from loss of data or profits arising out of, or in connection with, the use of this manual.

## WARRANTY

---

All AGD products are covered by a 12 month return to factory warranty. Products falling outside this period may be returned to AGD Systems for evaluation, repair, update or re-calibration, any of which may be chargeable.



### AGD Systems Limited

White Lion House  
Gloucester Road,  
Staverton, Cheltenham  
Gloucestershire, GL51 0TF, UK

**T:** +44 (0)1452 854212  
**F:** +44 (0)1452 854213  
**E:** sales@agd-systems.com  
**W:** agd-systems.com

